

## DIRECT

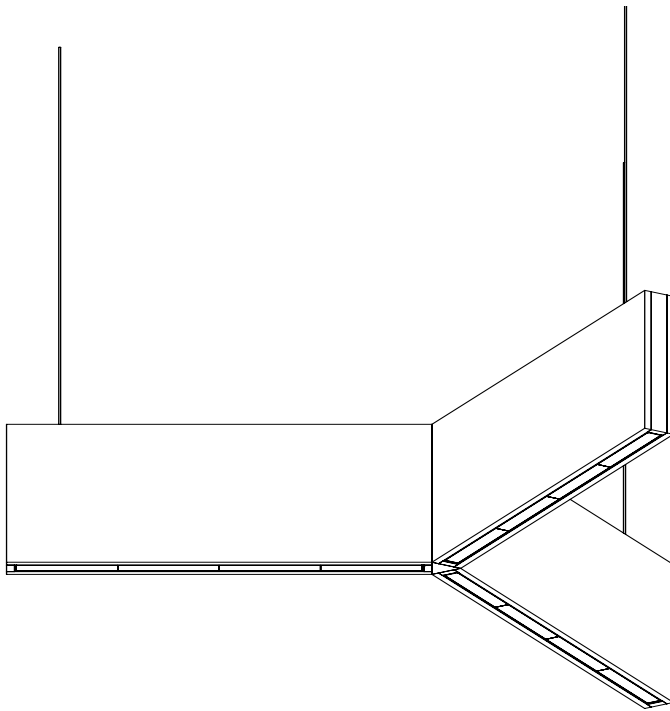

## OVERVIEW

### AIREBAFFLE™ TRIAD (DIRECT)

The AireBaffle™ Triad (Direct) provides a decorative, acoustic, down lighting fixture using Airelight™ Linear luminaires. Absorbing sound & emitting light, the AireBaffle™ TRIAD is the perfect combination of design and functionality. These suspended acoustic baffles come in different sizes and finishes.

## FEATURES

- Sound absorbing, light emitting, "Y" shaped baffle
- Integrated Airelight™ LED ceramic lighting
- Noise Reduction Coefficient (NRC) of 1.0
- Configurations: 4', 6' Diameters
- Eco-friendly acoustic material available in a variety of colors
- Use as a stand-alone pendant or grouping, or pair with other AireBaffle™ acoustic options

## DIMENSIONS

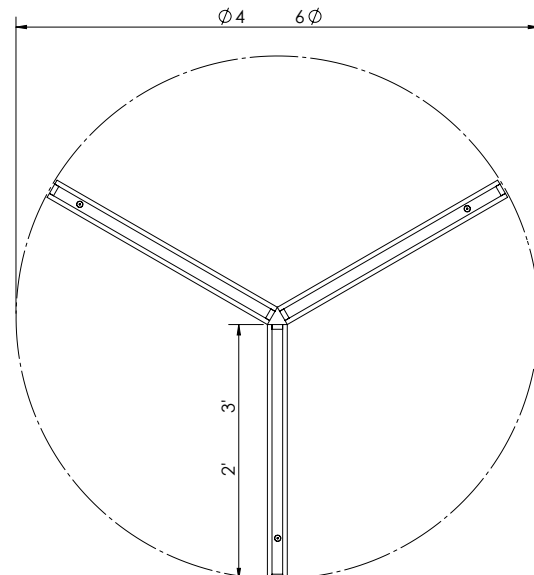

# AIREBAFFLE™ TRIAD (AIRELIGHT™ ACOUSTIC SERIES)



AIREBAFFLE™ TRIAD (AIRELIGHT™ ACOUSTIC SERIES)

DIRECT

## LIGHT SPECIFICATIONS

## PERFORMANCE















Light Fixture	Airelight™ Linear ES 1.0
Beam Angle	Lambertian
Lens Aperature	1" Wide
Directional Lighting	Direct
Controls	0-10VDC / Wireless
Rating	Suitable for Dry Locations

	<u>Linear ES 1.0</u>
Lumens Per Foot	755 @ 3500K
Efficacy (lms/W)	125 @ 3500K
Power Consumption	36W (4'Ø) ; 54W (6'Ø)
CRI	80+

## MATERIAL SPECIFICATIONS

Product Name	AireBaffle™ Triad (Direct)
Material	100% PET (~60% recycled content)
Mounting Hardware	Griplock® Powered Suspension System / Aircraft Cable
Warranty	5 year limited warranty
Size Range	Diameter(4', 6') x Height(8, 12, 16") <small>*Custom sizes available upon request*</small>
Environmental	Low-VOC material, meeting requirements for LEED and other green building certifications
Fire Rating	ASTME E-84 Class C (available with Class A treatment)
Acoustics	Calculated Acoustical Performance: NRC 1.0

## COLOR OPTIONS

				
105 W HEATHER	175 C HEATHER	345 DENIM	620 YELLOW	720 BLUSH
				
135 G HEATHER	190 BLACK	420 LIMON	630 ORANGE	735 FUSCHIA
				
155 S HEATHER	335 BLUE	430 LIME	645 RED	755 VIOLET

877.298.0092



goldeneyelighting.com

V1.5

# AIREBAFFLE™ TRIAD (AIRELIGHT™ ACOUSTIC SERIES)



AIREBAFFLE™ TRIAD (AIRELIGHT™ ACOUSTIC SERIES)

DIRECT

## ORDERING

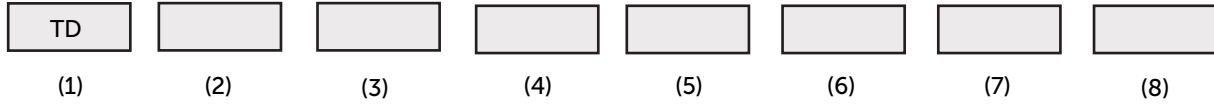

(1) BAFFLE TYPE	TD - TRIAD (Direct)	
(2) LIGHT FIXTURE	1 - 1.0 ES (1.0" Width)	
(3) DIAMETER	4 - 4' 6 - 6'	
(4) HEIGHT	8 - 8" 12 - 12" 16 - 16"	
(5) COLOR TEMP	27 or 27-90 - 2700K 80CRI or 90CRI 30 or 30-90 - 3000K 80CRI or 90CRI 35 - 3500K 80CRI 40 - 4000K 80CRI	
(6) SUSPENSION SYSTEM	PS - POWER SUSPENSION AC - AIRCRAFT CABLE	
(7) SUSPENSION LENGTH	<u>PS</u> 48 - 48" 120 - 120" 180 - 180" 240 - 240"	<u>AC</u> 24-24" 48 - 48" 96 - 96" 120- 120" 150 - 150" 180 - 180"

(8) BAFFLE COLOR

- |                        |              |               |
|------------------------|--------------|---------------|
| 105 - WHITE HEATHER    | 335 - BLUE   | 630 - ORANGE  |
| 135 - GREY HEATHER     | 345 - DENIM  | 645 - RED     |
| 155 - STEEL HEATHER    | 420 - LIMON  | 720 - BLUSH   |
| 175 - CHARCOAL HEATHER | 430 - LIME   | 735 - FUSCHIA |
| 190 - BLACK            | 620 - YELLOW | 755 - VIOLET  |